

Pill Shape shaving cab  
LED. On all sides of cab

Inner draw set-out with  
under mount basin

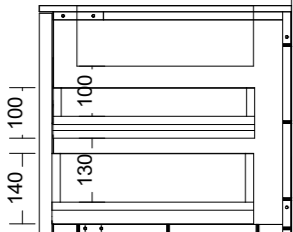

LED set-out on vanity  
cabinets

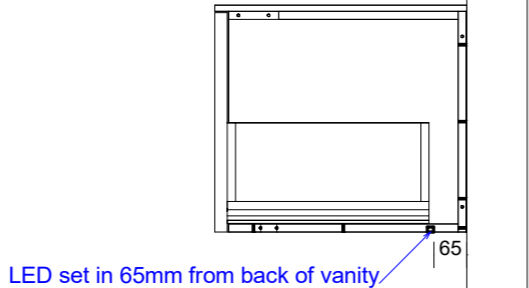

Inner draw set-out with  
top mount basin

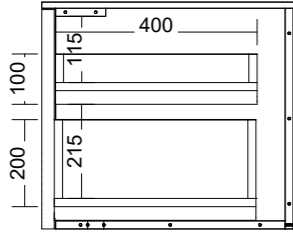

LED set-out on chrucl  
arch shaving cabinets

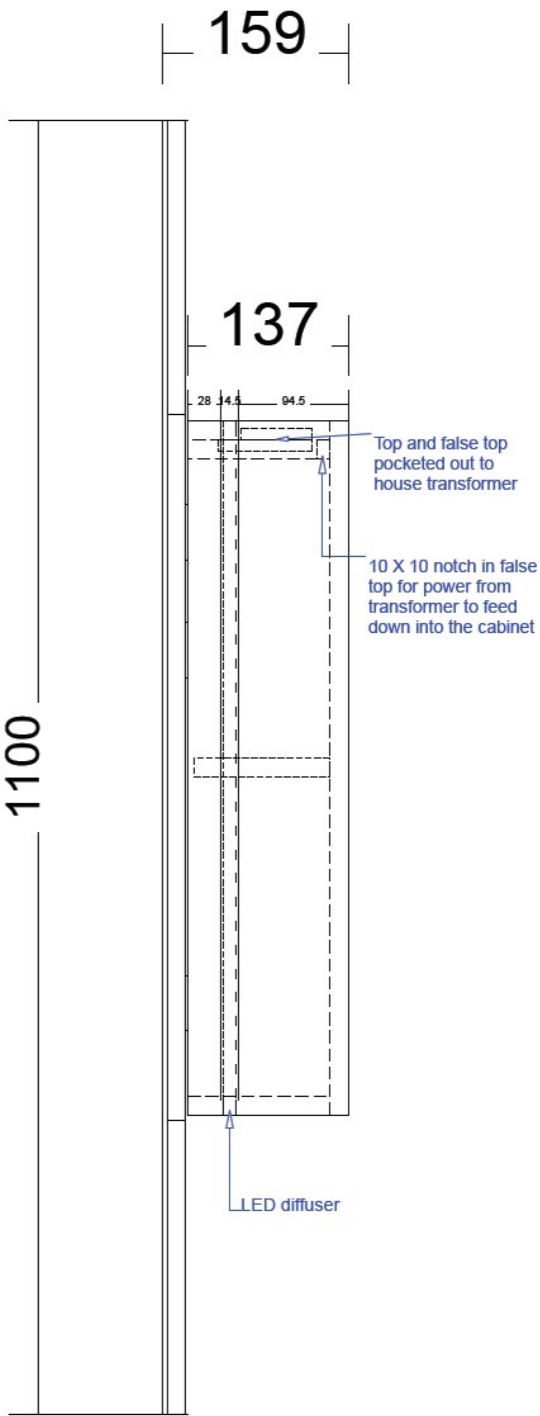
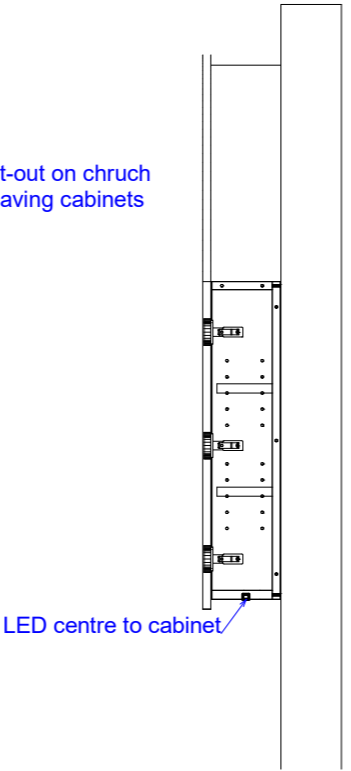

# Range:Accessories

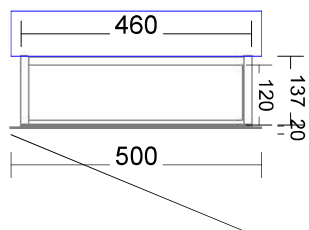

Internal Carcass: Selected by client  
 Upper Cabinet Doors, Panels and Fillers: Selected by client  
 Hinges: Grass Tiomos w/ integrated soft close

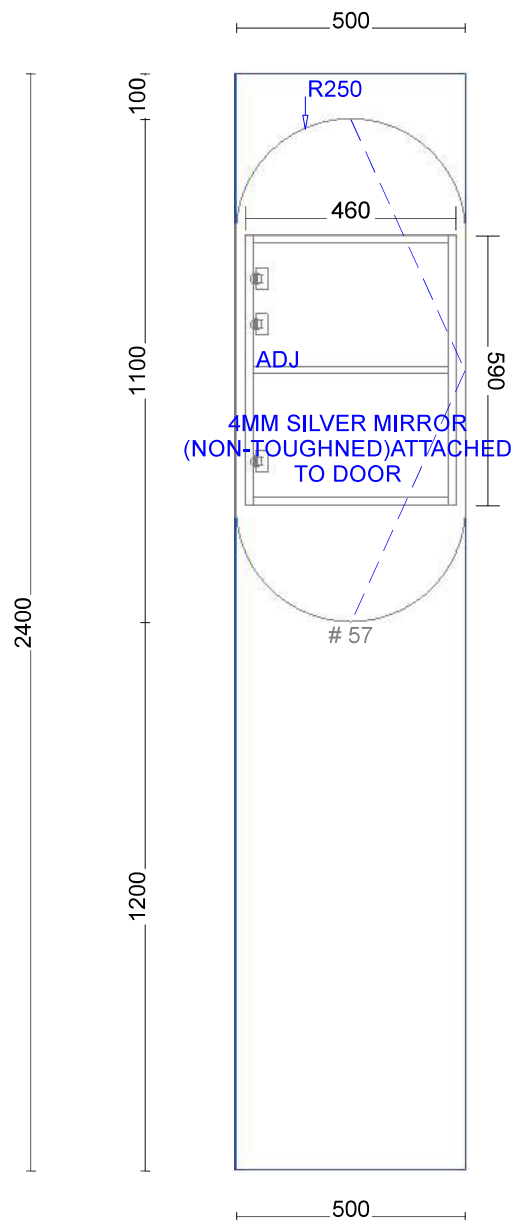

# Range: Pill Shape Shaving Cab Left

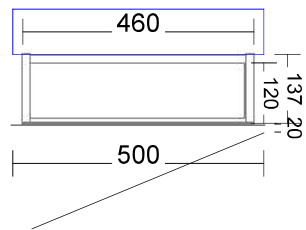

Internal Carcass: Selected by client  
 Upper Cabinet Doors, Panels and Fillers: Selected by client  
 Hinges: Grass Tiomos w/ integrated soft close

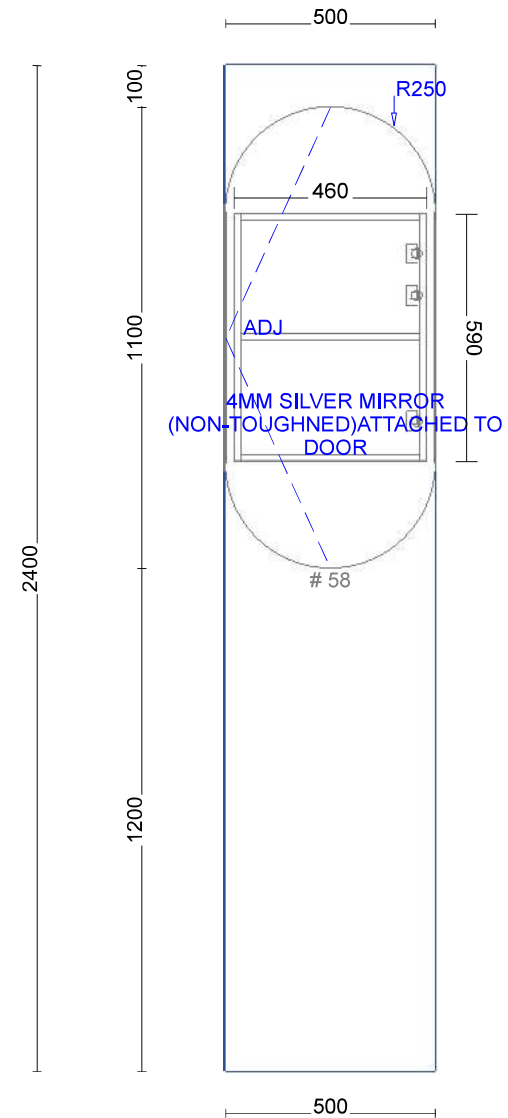

Name: Vanity Co  
 Address:  
 Phone:

Approved By:

Job: Vanity Co  
 Room: Pill Shape Shaving Cab Right  
 Date Issued: 19/07/21

All Items To Be Check Measured Before Manufactured